

FACTOR

— ELECTRONICS —

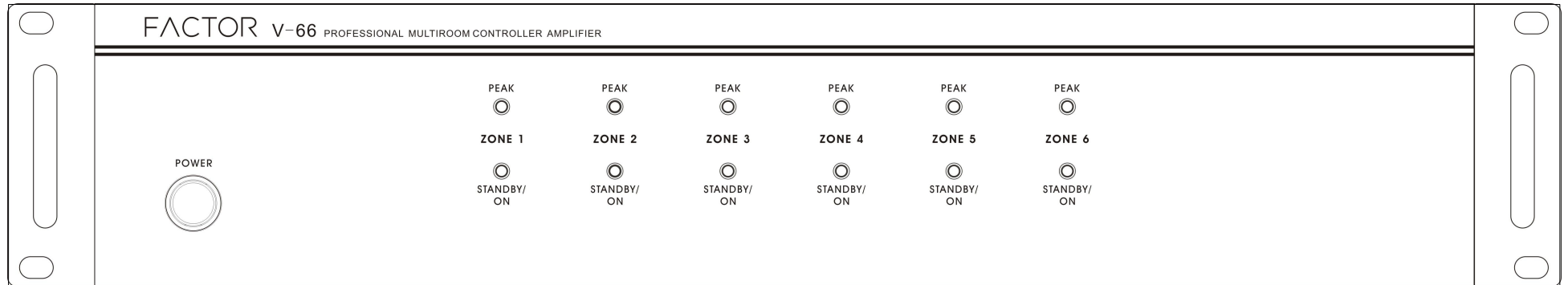

V-66

Professional Multi-room Multi-source Audio System

User and Installation Manual

SAFETY INSTRUCTIONS



WARNING! TO REDUCE THE RISK OF FIRE OR ELECTRIC SHOCK, DO NOT EXPOSE THIS APPLIANCE TO RAIN OR MOISTURE.

CAUTION! TO REDUCE THE RISK OF SHOCK, DO NOT REMOVE THE COVER, NO USER SERVICABLE PARTS INSIDE. REFER SERVICE TO A QUALIFIED SERVICE TECHNICIAN.

IMPORTANT SAFETY INSTRUCTIONS

- Read and keep these instructions.
- Heed all warnings and follow all instructions contained within this manual.
- Do not use this unit near water.
- Clean only with dry cloth.
- Do not block any ventilation openings. Install in accordance with the manufacturer's instructions.
- Do not install near any heat sources such as radiators, heat registers, stoves, or other apparatus (including amplifiers) that produce heat.
- Do not defeat the safety purpose of the polarized or grounding-type plug. A polarized plug has two blades with one wider than the other. A grounding type plug has two blades and a third grounding prong. The wide blade or the third prong are provided for your safety. If the provided plug does not fit into your outlet, consult an electrician for replacement of the obsolete outlet.
- Protect the power cord from being walked on or pinched particularly at plugs, convenience receptacles, and the point where they exit from the apparatus.
- Only use attachments/accessories specified by the manufacturer.
- Unplug this apparatus during lightning storms or when unused for long periods of time.
- Refer all servicing to qualified service personnel. Servicing is required when the apparatus has been damaged in any way, such as when the power-supply cord or plug is damaged, liquid has been spilled or objects have fallen into the apparatus, the apparatus has been exposed to rain or moisture, does not operate normally, or has been dropped.
- Operate the product only with the voltage specified on the unit. Fire and/or electric shock may result if a higher voltage is used.
- Do not modify, kink, or cut the power cord. Do not place the power cord in close proximity to heaters and do not place heavy objects on the power cord and/or the product itself, doing so may result in fire or electrical shock.
- Replace the protective cover over the speaker terminals after installation. Do not touch the speaker terminals as electric shock may result.
- Ensure that the safety ground terminal is connected to a proper ground. Never connect the ground to a gas pipe, as a severe explosion and/or fire may result.
- Be sure the installation of this product is stable, avoid slanted surfaces as the product may fall and cause injury, property damage, electrocution and/or fire.
- Note when the unit is turned off it is not completely disconnected from the wall AC power outlet. Do not open the cover. REFER ALL SERVICE TO A QUALIFIED SERVICE TECHNICIAN

PRODUCT OVERVIEW

Thank you for choosing the Factor Electronics V-66 multi-room multi-source audio system. The V-66 provides the ultimate audio control in six stereo zones (expandable to 18 stereo zones) without the need for programming. The V-66 is a true plug & play system while providing an extensive list of features for professional installations the V-66 was designed to be simple to operate and easy to install. The V-66 provides six audio inputs plus one digital optical input for Apple TV, Cable boxes, CD/DVD players and other high quality digital audio sources. Play music from your favourite CD collection or stream wireless music directly from your smart phone, PC or hand held music device using one of the many third party wireless internet streaming devices available today. The V-66 can also be managed and controlled from RS232 or Infrared enabled control systems completing your whole-house or business control system. Please take the time to read this entire manual to get the most from your V-66 audio system.

V-66 KIT

The V-66 kit includes the following parts:

1. 1 x V-66 Master Controller/Amplifier
2. 6 x V-66 Keypad Controllers
3. 1 x V-66 Keypad In-Wall Hub Connection Plate
4. 1 x V-66 Infrared Remote Controller
5. 1 x V-66 Expansion Ribbon Cable
6. 1 x Rack Mounting Kit
7. 1 x Installation Guide/Operation Manual

V-66 MASTER CONTROLLER/AMPLIFIER FRONT PANEL

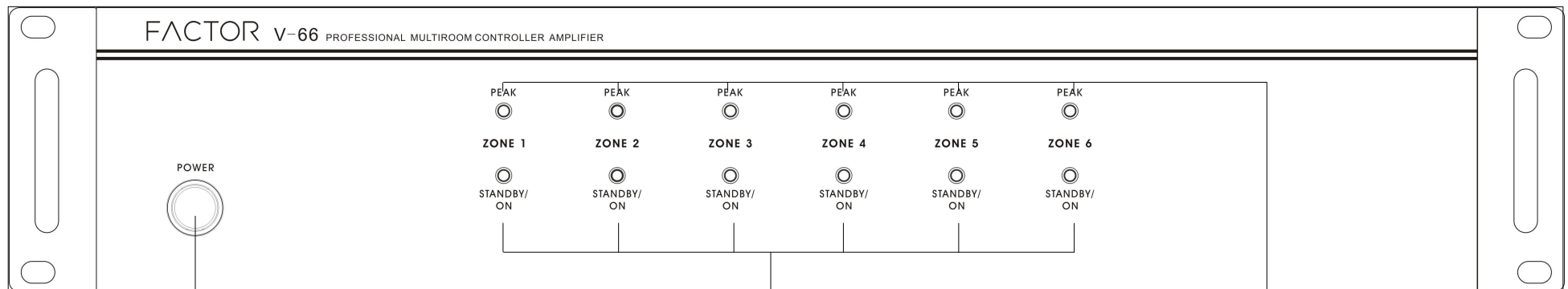

Power On/Off/ Standby
Press the power button IN to power the system ON. All zones will be in a standby state until a zone keypad is enabled.

Standby/Zone ON LED
All zones will be in standby until a zone keypad is enabled. The standby LED color is BLUE. Once a zone keypad is enabled the ON LED color will change to WHITE.

Peak LED
The PEAK LED is a warning light to indicate the connected source level is too high. If the PEAK LED lights solid RED reduce the input or output level in the affected zone.

V-66 MASTER CONTROLLER/AMPLIFIER REAR PANEL

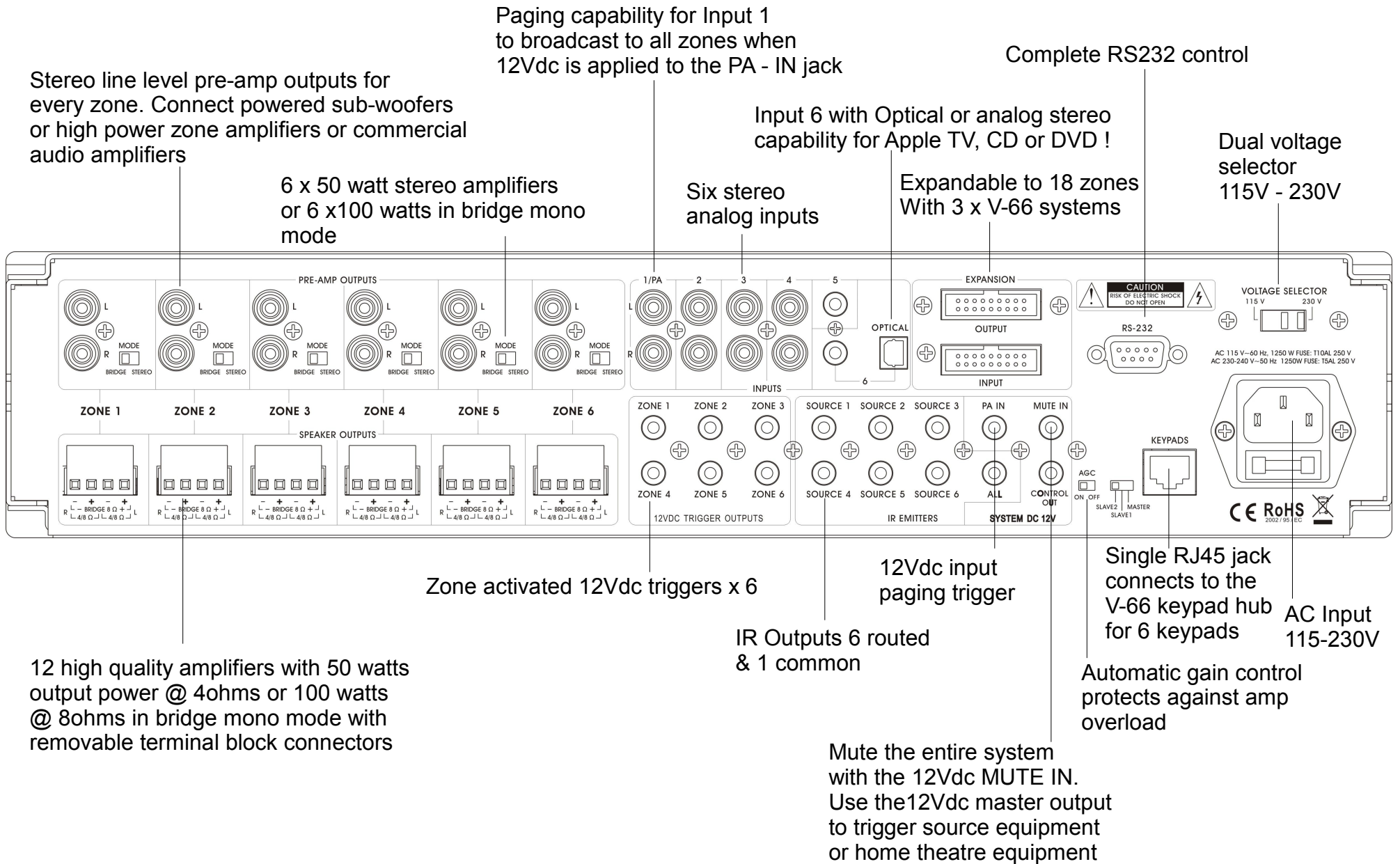

V-66 KEYPAD FEATURES

The V-66 keypads are available in white (V-66-WKP) and black (V-66-BKP). The V-66 keypad is designed to be very easy to use. Five backlit buttons access zone power on/off, volume up/down, selection of sources 1-6, zone treble, zone bass, zone un-mute and zone standby. The backlit LED display provides visual feedback of levels and source numbers. The V-66 keypad also provides an Infrared receiver which allows complete zone control via the included V-66-RC hand held remote control. The V-66 IR system also sends IR commands to the V-66 master controller IR output jacks for remote control of your source components. No programming necessary, just touch the keypad and start playing music instantly!

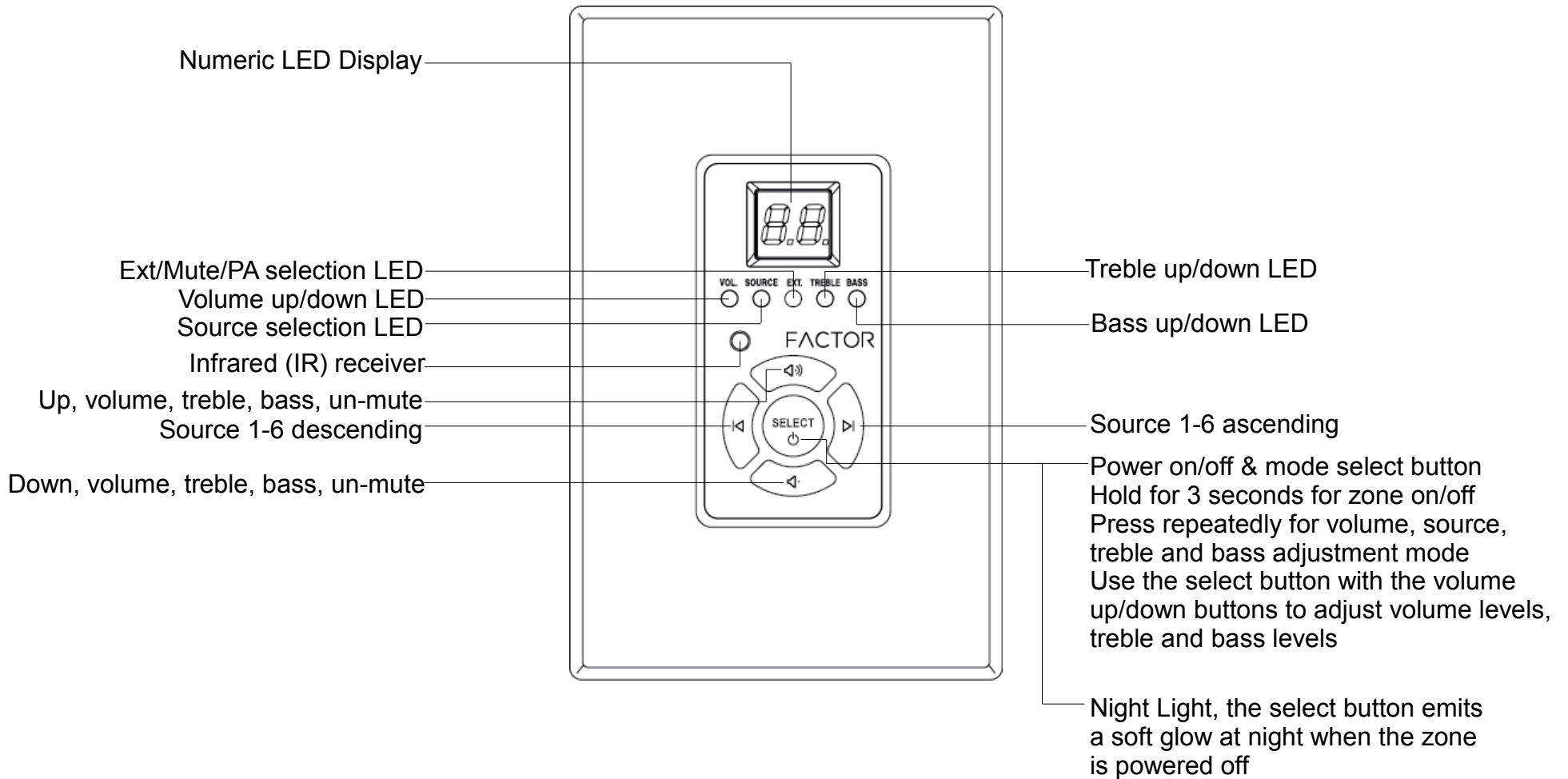

V-66-RC INFRARED REMOTE CONTROL FEATURES

The V-66-RC Infrared remote control provides complete zone control through the (IR) receiver located in the center of the V-66 keypad. All keypad functions can be accessed with the V-66-RC. In addition to this the V-66-RC provides a handy MUTE button to temporarily mute audio in the zone and left/right balance adjustment. Once the MUTE function is activated the keypad numeric LED display will flash indicating the mute status. Press the MUTE button again to return to playing music. Pressing the volume up/down buttons on the keypad will also un-mute the zone and return to playing music.

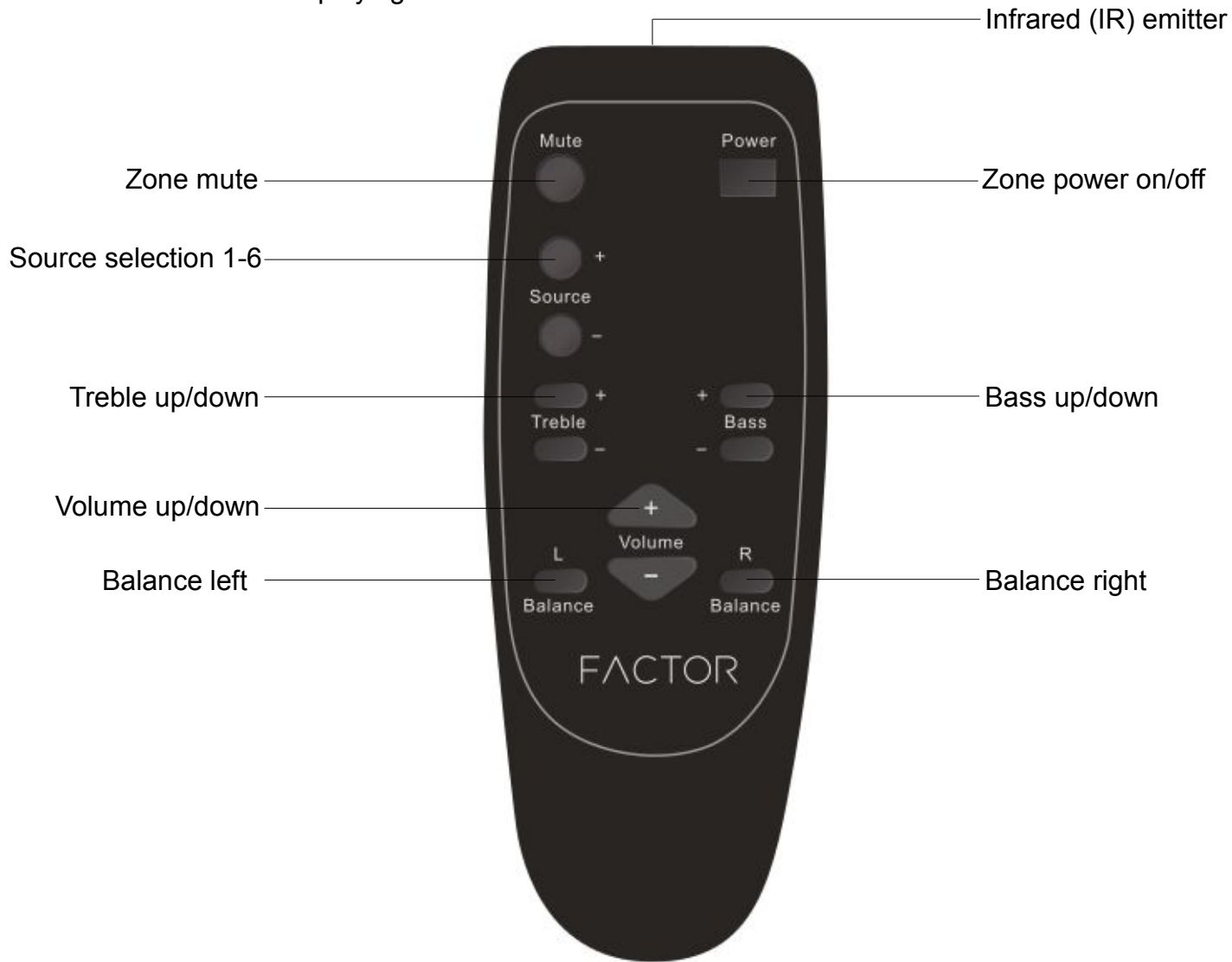

V-66 INSTALLATION INSTRUCTIONS

IMPORTANT: The V-66 should be situated in a well ventilated location or position. Do not block the vents on the sides or top of the chassis. Proper ventilation is required for normal operation. Do not expose the unit to excessive dust and do not allow dust to build up on the unit and block the vent holes in the chassis. Do not place the V-66 above or below heat-generating components such as another audio amplifier. Be sure to leave at least 2 inches of space to the sides of the chassis with open air flow above and below the unit.

INSTALLATION:

1. The V-66 can be mounted in an equipment rack using the rack kit that is included with the V-66.
2. Always disconnect the AC power cord before making any connections to the V-66 controller.
3. Use good quality 12-14awg 2 conductor stranded copper speaker wire for all speaker connections.
4. Use good quality cat5e or cat6 cable and RJ45 connectors for all V-66-KP (keypads).
5. The V-66 includes a central keypad hub. All V-66-KP (keypads) will be home run back the the hub. Keep the hub close the V-66 controller.
6. Wire all cat5e/cat6 cables exactly the same using TIA/EIA 568A wiring. Do not use crossover cables.

IMPORTANT: All V-66-KP keypads must have their mode dip switches set properly before powering the system on.

Failure to set the keypad mode dip switches correctly will result in no communication between the V-66 controller and the V-66-KP (keypad). The keypad mode switches are located on the back panel of each keypad. The dip switches set the zone location and communication of each individual keypad.

SETTING THE KEYPAD MODE DIP SWITCHES AND KEYPAD WIRING:

Each V-66-KP shows a handy mode selection chart on the back of the keypad as follows: Switch in the up position is ON. Switch in the down position is OFF.

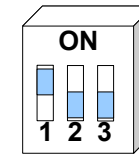

ZONE-1			ZONE-2			ZONE-3		
ON	ON	OFF	ON	OFF	ON	ON	OFF	OFF
1	2	3	1	2	3	1	2	3
ZONE-4			ZONE-5			ZONE-6		
OFF	ON	ON	OFF	ON	OFF	OFF	OFF	ON
1	2	3	1	2	3	1	2	3

IMPORTANT: Use a screwdriver to install the keypad. Using a power drill can damage the keypad.

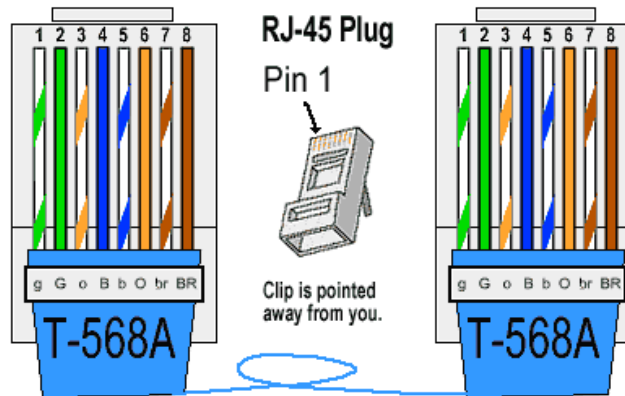
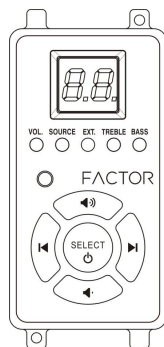
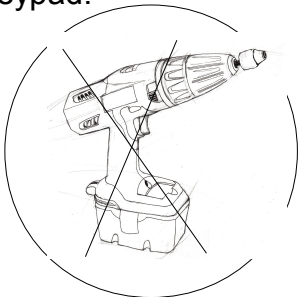

TIA/EIA 568A Wiring

1	White and Green
2	Green
3	White and Orange
4	Blue
5	White and Blue
6	Orange
7	White and Brown
8	Brown

V-66-KP (keypad) INSTALLATION INSTRUCTIONS

IMPORTANT: The V-66-KP (keypad) should be mounted in an electrical box or in-wall mud ring using a screwdriver to tighten. Do not use a power drill to tighten the keypad screws. Over tightening can damage the keypad.

INSTALLATION: Connecting the V-66-KP (keypads)

Use a good quality Cat5e/6 cable and crimp RJ45 jacks on each end of the cables.

The RJ45 jack plugs into the back panel of the keypads and the 6 x RJ45 jacks on the back panel of the V-66-Keypad-Hub.

The V-66-Keypad-Hub is included in your V-66 kit. Plug the RJ45 jacks into any available jack on the V-66-Keypad-Hub.

Zone assignment is determined by the MODE dip switches on the back of the V-66-KP (keypad).

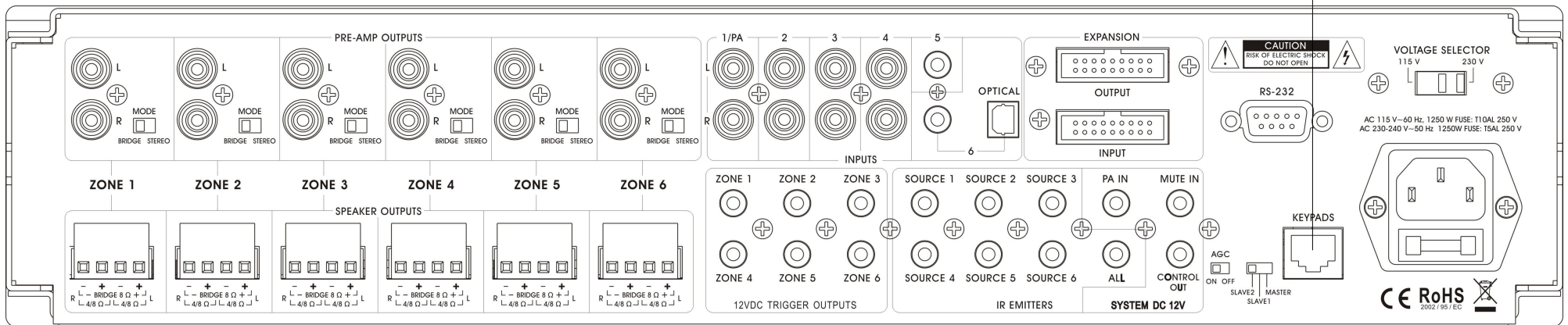
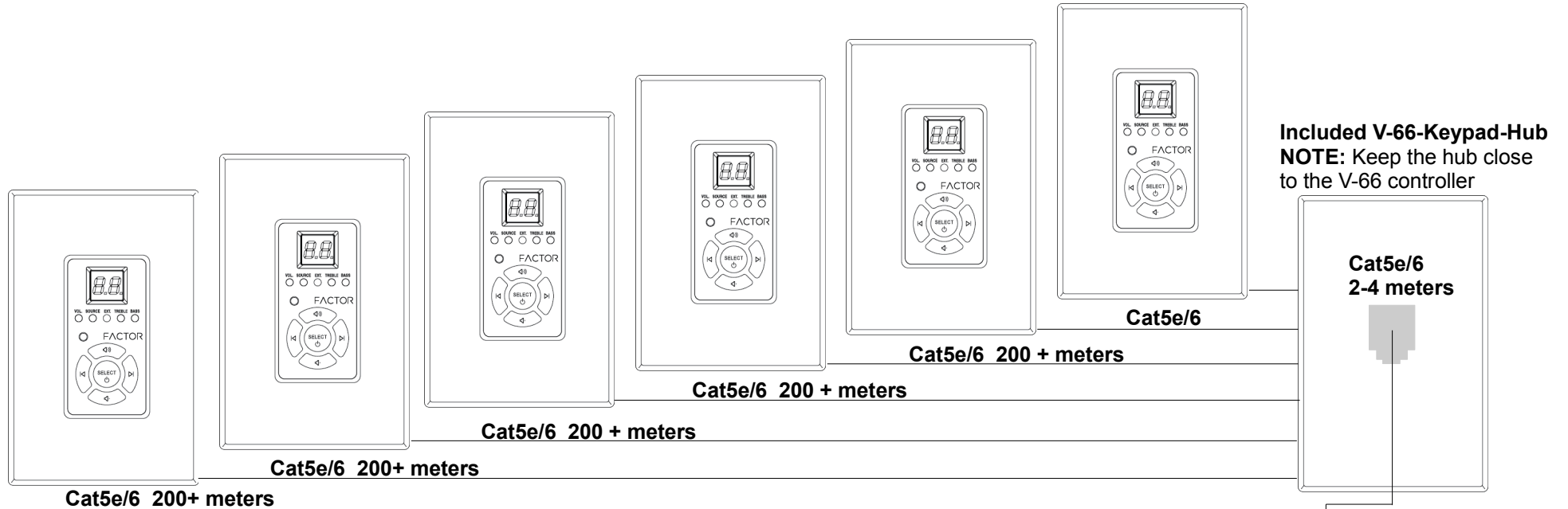

V-66 SPEAKER INSTALLATION INSTRUCTIONS STEREO MODE

IMPORTANT: The V-66 amplifiers are capable of driving 4-8 ohm speaker loads in stereo mode and 8ohm loads in bridge mono mode. Never connect more than two 8ohm speakers wired in parallel to a single amplifier channel in stereo mode. Never connect more than one 8ohm speaker to a single channel in bridge mono mode. Never connect the Left & Right channels of the amplifier together. Never combine the – negative channels of the amplifier together. Improper speaker installation can damage the amplifiers and void the warranty. If you are unsure how to connect speakers to the V-66 always contact a qualified Factor Electronics technician before connecting speakers to the amplifiers.

INSTALLATION: Connecting 8 ohm speakers to the V-66 in STEREO MODE

Use good quality 12-14awg stranded copper speaker wire. Never run speaker wires parallel to AC wires. If you must cross AC wires always cross at a 90 degree angle. The speaker output terminal block connectors are removable. Remove the terminal block connector and make sure that all connections are open by turning each set screw counter clockwise. This insures that the speaker wire opening is completely open. Trim approx 1/4" of insulation from the speaker wire and twist the copper ends. Insert the speaker wires into the connector and tighten the set screws. Repeat for the remaining zones.

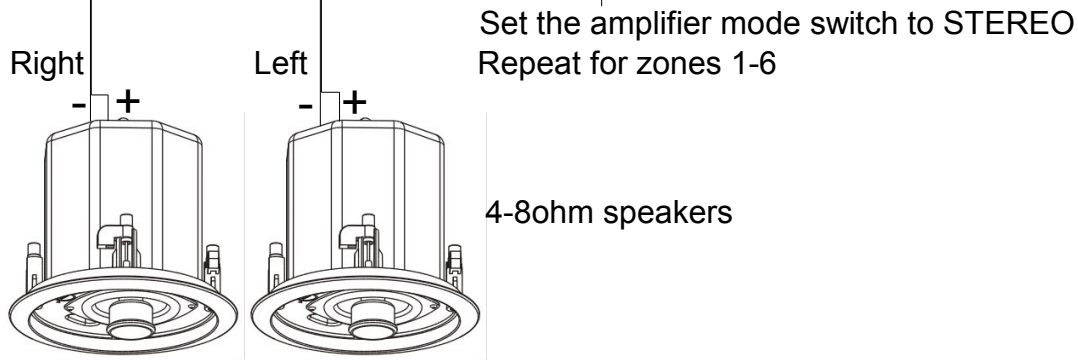
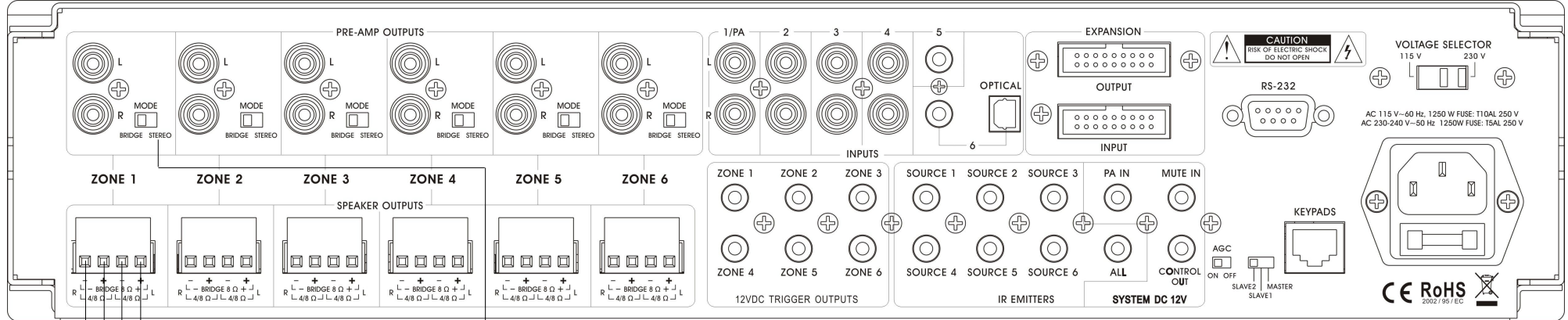

V-66 SPEAKER INSTALLATION INSTRUCTIONS BRIDGE MODE

IMPORTANT: The V-66 amplifiers are capable of driving 8 ohm speaker loads in in bridge mono mode. Never connect more than one 8ohm speaker to a single channel in bridge mono mode. Never combine the – negative channels of the amplifier together. Improper speaker installation can damage the amplifiers and void the warranty. If you are unsure how to connect speakers to the V-66 always contact a qualified Factor Electronics technician before connecting speakers to the amplifiers.

INSTALLATION: Connecting 8 ohm speakers to the V-66 in BRIDGE MODE

Setting the amplifier mode switch to BRIDGE mode will double the amplifier power output to 100 watts. Effectively combining the LEFT and RIGHT amplifiers into one larger mono amplifier. The LEFT and RIGHT input signals will be summed to mono. The minimum speaker impedance in bridge mode is 8ohms. Use good quality 12-14awg stranded copper speaker wire. Never run speaker wires parallel to AC wires. If you must cross AC wires always cross at a 90 degree angle. The speaker output terminal block connectors are removable. Remove the terminal block connector and make sure that all connections are open by turning each set screw counter clockwise. This insures that the speaker wire opening is completely open. Trim approx 1/4" of insulation from the speaker wire and twist the copper ends. Insert the speaker wires into the connector and tighten the set screws. Repeat for the remaining zones.

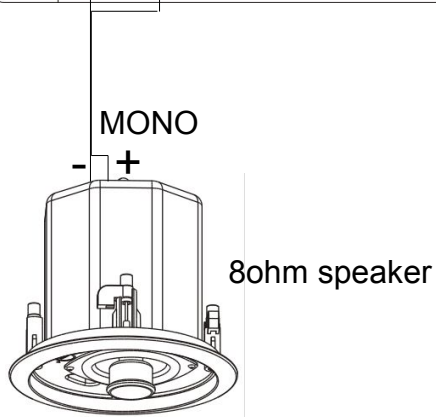
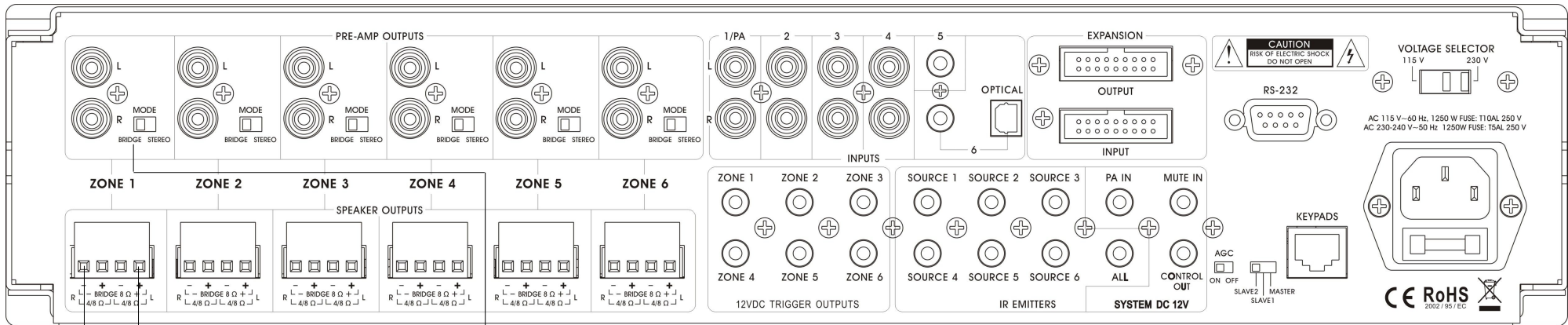

Set the amplifier mode switch to BRIDGE
Repeat for zones 1-6
NOTE: It is possible to set some amplifier channels to BRIDGE and some to STEREO.
Follow the correct wiring techniques and correct speaker impedance for each zone.

V-66 INSTALLATION INSTRUCTIONS PRE-AMP OUTPUTS

INSTALLATION: Using The V-66 PRE-AMP OUTPUTS

The V-66 provides 6 x stereo unbalanced line level PRE-AMP outputs which correspond to the 6 x zone outputs. PRE-AMP outputs can be used to connect powered subwoofers to a zone or additional amplifiers to expand the available power in a large zone or multiple zones. The V-66 can also be used as the master controller in large commercial audio systems where constant voltage 25/70V amplifiers can be connected to the PRE-AMP outputs. The PRE-AMP output levels are variable and can be controlled from the V-66-KP keypad, infrared or RS232. Keep the PRE-AMP output cable runs under 25 feet to avoid RF interference and use good quality shielded RCA cables.

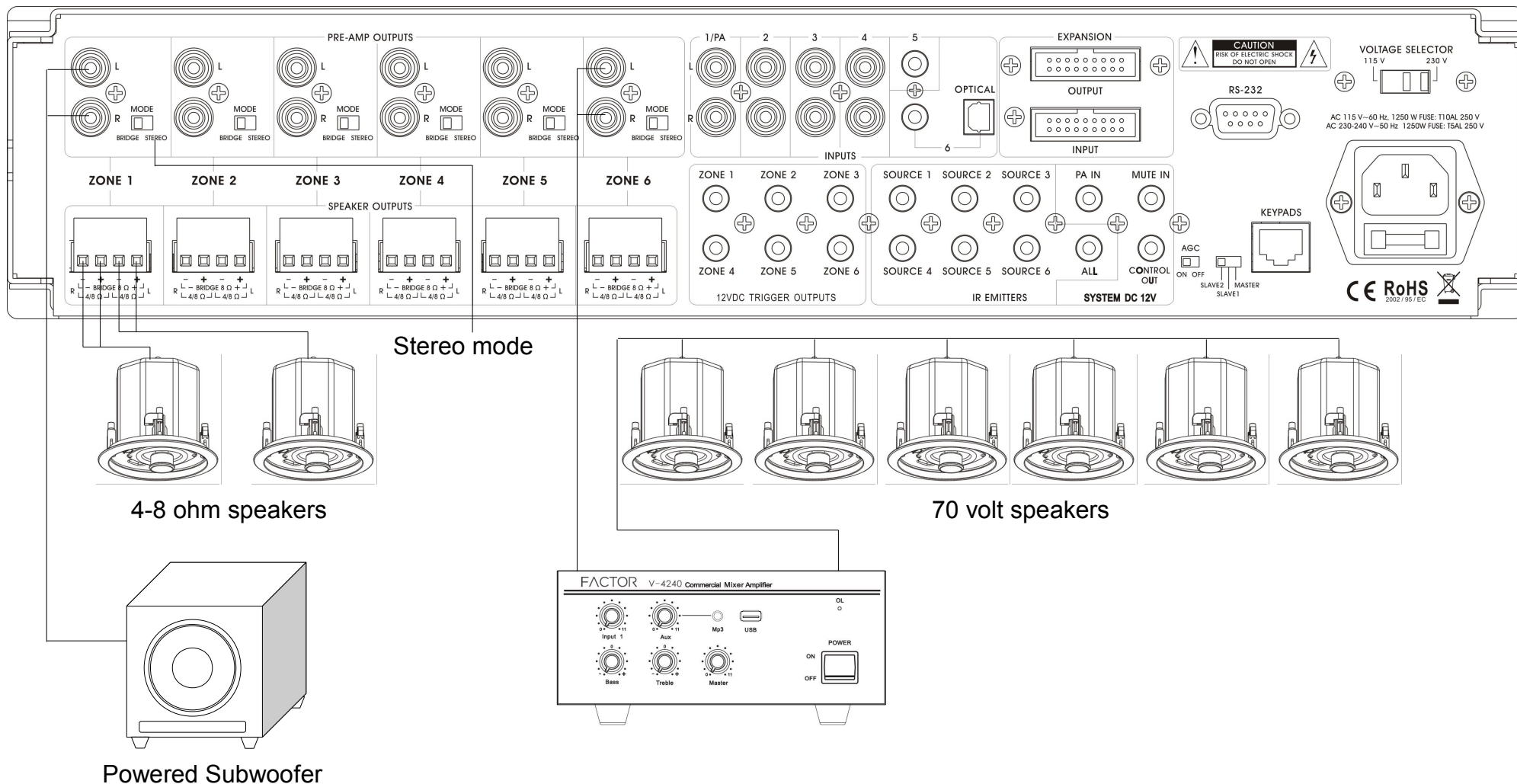

V-66 INSTALLATION INSTRUCTIONS CONNECTING SOURCES

INSTALLATION: Connecting Sources to the V-66

The V-66 provides 6 x stereo unbalanced line level source inputs which can be accessed by any zone. Inputs 5 and 6 provide inputs on 3.5mm stereo jacks and input 6 also provides one SPDIF Digital Optical input for digital sources like Apple TV, DVD and CD players or cable/ satellite boxes. The input 6 - 3.5mm stereo jack takes priority over the input 6 SPDIF input. Do not connect cables to both the 3.5mm stereo input and the SPDIF Digital input at the same time. Input 1 can be used as a paging (all zones) input or a party mode (all zones) input. When a source is connected to input 1 and 12VDC is applied to the PA-IN jack (**3.5mm tip+ sleeve -**), source 1 will be broadcast in all zones. If there is no DC voltage applied to the PA-IN jack then source 1 will act like all the other 5 sources and broadcast only when a zone selects source 1. Always use good quality shielded RCA cables to connect sources to the V-66 and keep RCA cables as short as possible to avoid RF interference.

Infrared Emitter Outputs:

Each source has a corresponding Infrared (IR) emitter output. These outputs are used to control the connected source components remotely through the V-66 IR system. Connect an IR emitter like the Factor Electronics IR-1-FLASH to the Source 3 IR Emitter output jack and then connect the flasher to the IR receiver window on source 3. Now you can use a master remote control or the source 3 remote control in any zone and control your source through the V-66-KP (keypad) remotely. The V-66-KP (keypad) should have the corresponding source 3 selected for the IR to work. Repeat this for all your Infrared (IR) enabled sources for complete IR source control.

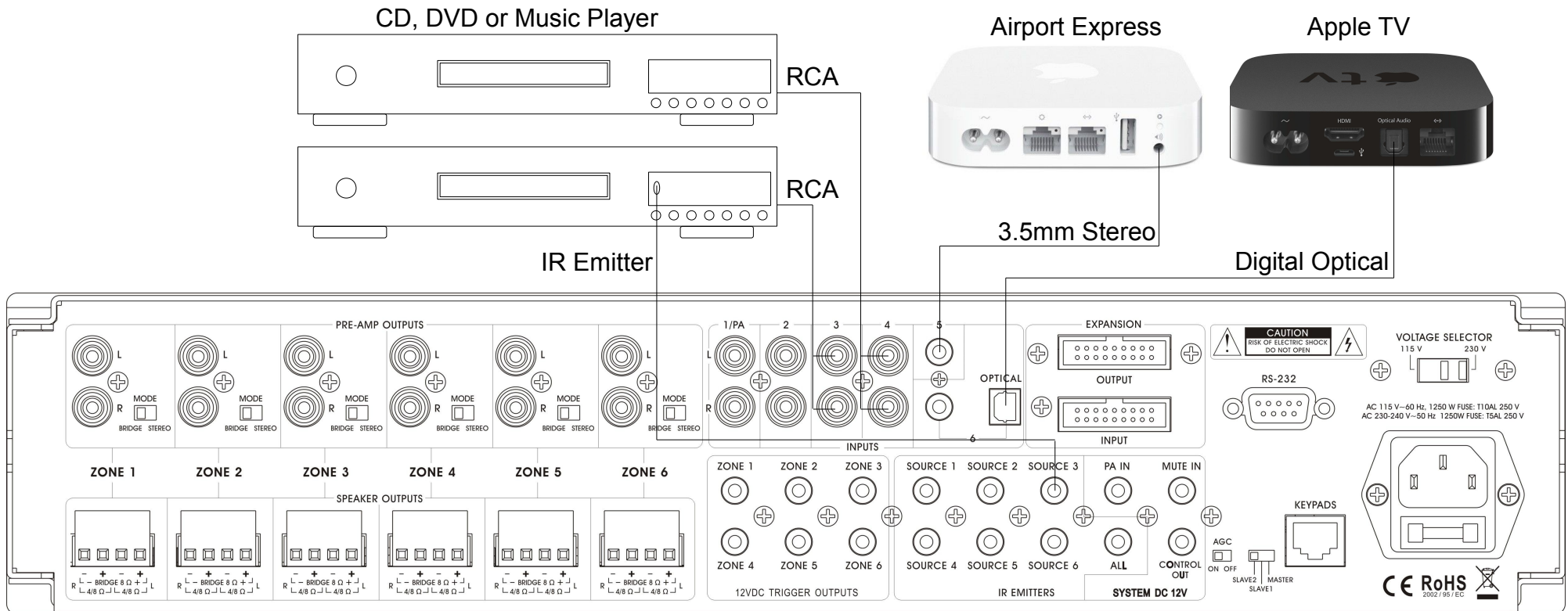

V-66 INSTALLATION INSTRUCTIONS USING THE 12V TRIGGERS

INSTALLATION: Using the V-66 12VDC Trigger Inputs and Outputs

The V-66 provides 6 x 12VDC trigger outputs which correspond to the 6 x V-66 zones. When a zone is powered ON by pressing and holding the SELECT button on the V-66-KP (keypad) for 3 seconds the corresponding zone sends 12VDC to the trigger output jack. When the zone is powered OFF the routed 12VDC signal is disengaged. Triggers can be used to automatically power peripheral equipment ON/OFF with the V-66 zones. The V-66 also provides a master control 12VDC trigger output which sends 12VDC to the CONTROL OUT jack when any zone is powered ON. The 12VDC CONTROL OUT signal is disengaged when all zones are powered OFF.

V-66 Trigger outputs:

ZONE 1-6: Zone ON 12VDC applied to output jack Zone OFF 12VDC disengaged

CONTROL: Any zone ON 12VDC applied to output jack Zone OFF 12VDC disengaged

V-66 Trigger Inputs:

PA- IN- Insert 12VDC and Input 1 takes priority over all other inputs and broadcasts to all 6 zones.

MUTE - IN- Insert 12VDC and all zones will be muted. (no sound)

WIRING: 3.5mm Mono Plug (Tip + / Sleeve -) 

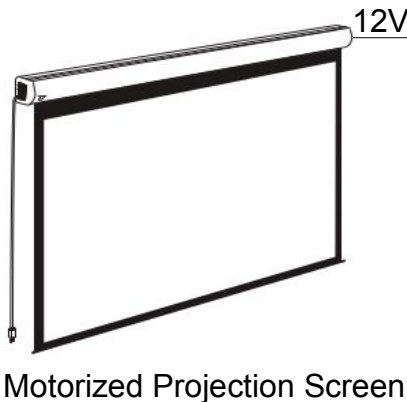
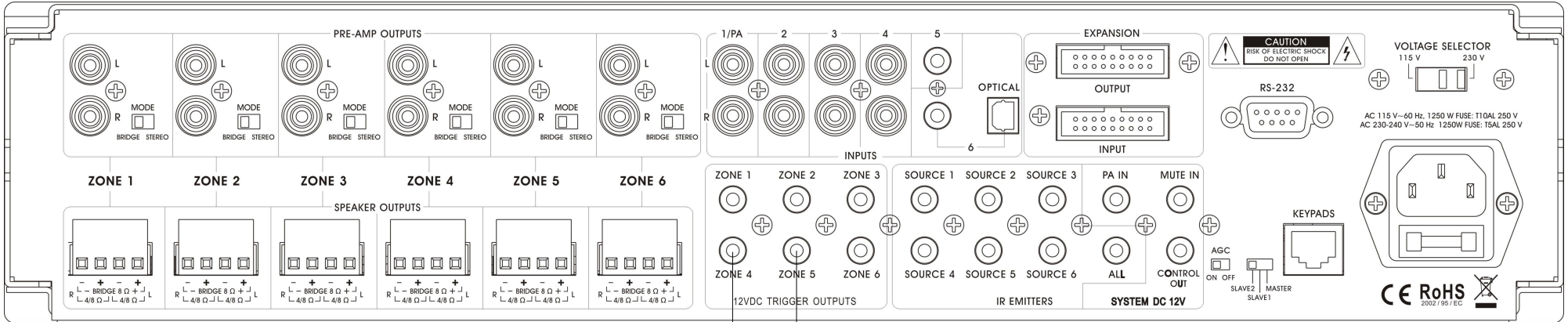

12VDC Trigger In

12VDC Trigger In

External Amplifier Control

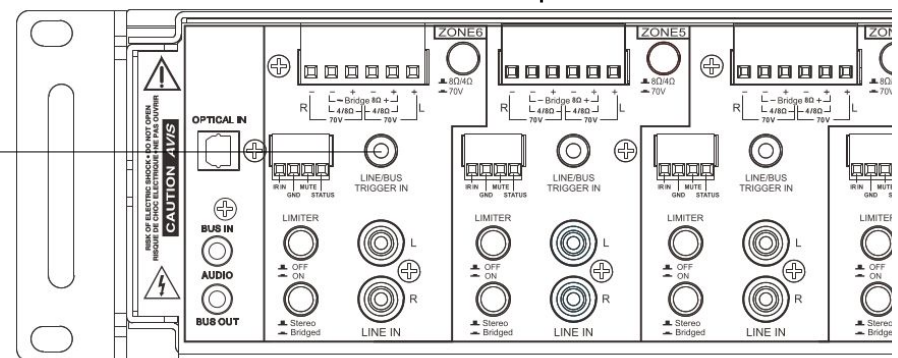

V-66 INSTALLATION INSTRUCTIONS EXPANSION

INSTALLATION: Expanding the V-66 to 18 zones

The V-66 provides an 18 pin expansion cable with the V-66 kit. The V-66 can be expanded up to 18 zones using three complete V-66 kits. Connect the expansion cable from the lowest unit output and cascade the units from output to input. Next you must select which unit will be the **MASTER**, **SLAVE 1**, & **SLAVE 2** units using the select switch. Connect all sources to the **MASTER** unit.

The following data and control is provided between units using the expansion cable.

1. All source audio information.
2. All RS232 control data.
3. All MCU communication between the master and slave units.
4. NOTE: IR zone outputs will each require a separate flasher connected to your source components for control to function from every zone. The MASTER V-66 unit IR outputs will function as normal however the IR outputs from SLAVE 1 & 2 will not pass through the MASTER V-66 IR outputs when the IR signal is send from SLAVE 1 & 2 zones.

SLAVE 2

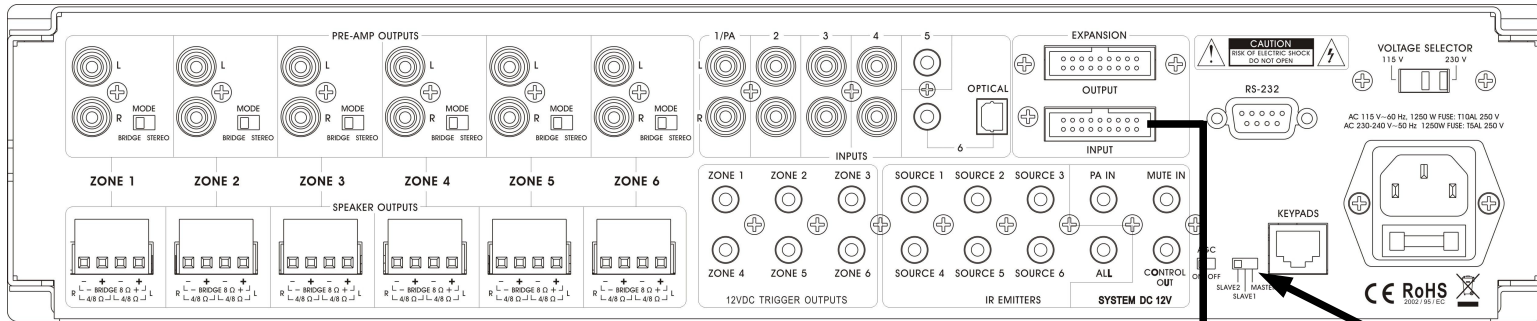

SLAVE 1

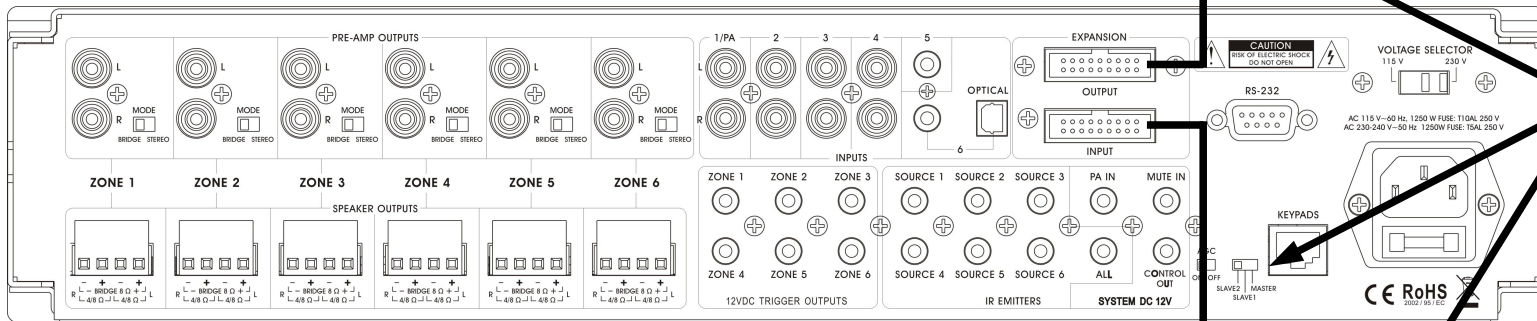

MASTER

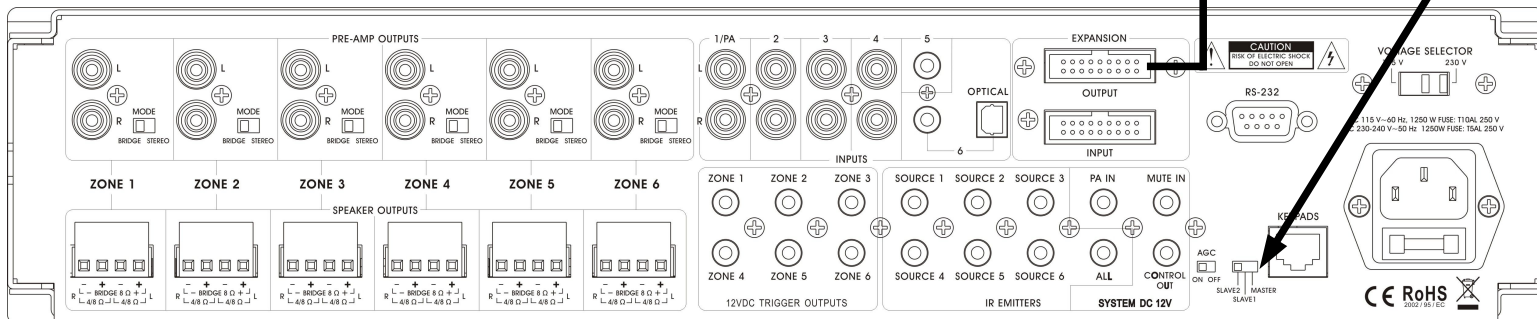

Master
Slave
Select

INSTALLATION: V-66 RS-232 Serial Port Control

The V-66 provides an RS-232 serial port connection located on the back panel of the V-66 and uses a DB-9 cable connection. The V-66 supports bi-directional RS-232 communication with third party automation systems. All keypad and remote control operations can be controlled via RS-232 in addition to system expansion up to 18 zones or 3 master controller units linked together using the included 18 pin expansion cable. (**Baud Rate 9600, 8, N, 1 , DB9 Connector Pin out, Tx, Rx, GND**)

V66 RS-232 CONTROL

'CR':Carriage Return (0x0D)

No case capitalization/ lowercase

Control order structure <xxPPuu'CR'

Reply control order frame >xxPPuu'CR'

xx: stands for control object code

10 :All Zone of Main unit 1.

20 :All Zone of Main unit 2.

30 :All Zone of Main unit 3.

:Zone1 of Main unit 1.

:Zone2 of Main unit 1.

:Zone3 of Main unit 1.

.....

PP: Stands for control action code.

PR:Power control

PR00:Power off PR01:Power on

MU:Mute control

MU00:Mute off MU01:Mute on

DT:Do Not Disturb control

DT00:DT control off

DT01:DT control on

VO:Volume control

VO(00-38):Volume control

TR:Treble control

TR(00-14):Treble control

BS:Bass control

BS(00-14):Bass control

BL:Balance control

BL(00-20):Balance control

CH:Source Channel control

CH(01-06):Source control

Inquiry command structure (1) ?xx'CR'

xx: stands for control object code

10 : All Zone of Main unit 1.

20 : All Zone of Main unit 2.

30 : All Zone of Main unit 3.

: Zone1 of Main unit 1

: Zone2 of Main unit 1

: Zone3 of Main unit 1

: Zone1 of Main unit 2

: Zone2 of Main unit 2

: Zone3 of Main unit 2

.....

Reply command: >xxaabbccddeeffgghhijj'CR'

aa: PA control status

bb: Power control status ([5]:Backup Zone Power

Status

(only on zone)

cc: Mute control status

dd: DT control status

ee: Volume control status

ff: Treble control status

gg: Bass control status

INSTALLATION: V-66 RS-232 Serial Port Control

The V-66 RS-232 Serial commands continued.

(Baud Rate 9600, 8, N, 1 , DB9 Connector Pin out, Tx, Rx, GND)

hh: Balance control status
ii: Source control status
jj: keypad connecting status
(00:disconnect 01:connected)
Inquiry command structure (2) ?xxPP'CR'
xx: stands for control object code
10 : All Zone of Main unit 1.
20 : All Zone of Main unit 2.
30 : All Zone of Main unit 3.
11 : Zone1 of Main unit 1
12 : Zone2 of Main unit 1
13 : Zone3 of Main unit 1
14 : Zone4 of Main unit 1
15 : Zone5 of Main unit 1
16 : Zone6 of Main unit 1

PP: Stands for control action code.

PA: PA control

PR: Power control

MU: Mute control

DT: DT control

VO: Volume control

TR: Treble control

BS: Bass control

BL: Balance control

CH: Source control

LS: keypad connecting status

Reply command: >xxPPuu'CR'

Key in 1<*****'CR' change Source 1 Name
display;*****needs to be 8 valid ASCII codes.

Key in 2<*****'CR' change Source 2 Name
display

Key in 3<*****'CR' change Source 3 Name
display

Key in 4<*****'CR' change Source 4 Name
display

Key in 5<*****'CR' change Source 5 Name
display

Key in 6<*****'CR' change Source 6 Name
display

Key in M<*****'CR' change the name display on
keypad when turn on.

Key in <9600'CR' change RS232 speed rate to 9600

Key in <19200'CR' change RS232 speed rate to
19200

Key in <38400'CR' change RS232 speed rate to
38400

Key in <57600'CR' change RS232 speed rate to
57600

Key in <115200'CR' change RS232 speed rate to
115200

Key in <230400'CR' change RS232 speed rate to
230400

**When unplugging and re-plugging the AC power
cord, the baud speed rate returns to 9600.**

ee: Volume control status

ff: Treble control status

gg: Bass control status

hh: Balance control status

ii: Source control status

jj: keypad connect status

INSTALLATION: V-66 RS-232 Serial Port Control

The V-66 RS-232 Serial commands continued.

(Baud Rate 9600, 8, N, 1 , DB9 Connector Pin out, Tx, Rx, GND)

(00:disconnect 01:connected)
Inquiry command structure (2) ?xxPP'CR'
xx: stands for control object code
10 : All Zone of Main unit 1.
20 : All Zone of Main unit 2.
30 : All Zone of Main unit 3.
11 : Zone1 of Main unit 1
12 : Zone2 of Main unit 1
13 : Zone3 of Main unit 1
14 : Zone4 of Main unit 1
15 : Zone5 of Main unit 1
16 : Zone6 of Main unit 1

PP: Stands for control action code.

PA: PA control

PR: Power control

MU: Mute control

DT: DT control

VO: Volume control

TR: Treble control

BS: Bass control

BL: Balance control

CH: Source control

LS: keypad connecting status

Reply command: >xxPPuu'CR'

Reply command: >xxPPuu'CR'

;*****needs to be 8 ASCII codes.

Key in 1<*****'CR' change Source 1 Name display

Key in 2<*****'CR' change Source 2 Name display

Key in 3<*****'CR' change Source 3 Name display

Key in 4<*****'CR' change Source 4 Name display

Key in 5<*****'CR' change Source 5 Name display

Key in 6<*****'CR' change Source 6 Name display

Key in M<*****'CR' change the name in the display

On the keypad when the keypad is turned on.

Key in <9600'CR' change RS232 speed rate to 9600

Key in <19200'CR' change RS232 speed rate to 19200

Key in <38400'CR' change RS232 speed rate to 38400

Key in <57600'CR' change RS232 speed rate to 57600

Key in <115200'CR' change RS232 speed rate to 115200

Key in <230400'CR' change RS232 speed rate to 230400

When unplugging and re-plugging the AC power cord, the

Baud speed rate will return to 9600.

V-66 SPECIFICATIONS & WARRANTY

RMS Power @ 8 ohms	25 watts x 12
RMS Power @ 4 ohms	50 watts x 12
RMS Power @ 8 ohms Bridge Mode	100 watts x 6
S/N Ratio	>85dB A Weighted
THD	<0.1%
Frequency Response	20Hz - 20kHz
Input Impedance	>47 K Ohms
Input Sensitivity	250mv
Amplifier Protection	Overload, Short Circuit & Thermal
Trigger Systems ON Voltage	DC + 12V
Trigger External Mute Voltage	DC + 12V
Infrared Frequency	38kHz
Input Connectors	3.5mm stereo, RCA, SPDIF
Output Connectors	Terminal Block, 3.5mm mono
Power Supply (switchable)	AC115V/60Hz, 230V/50Hz
Dimensions mm	430 W x 89 H x 416 D
Weight	11kg
Warranty	3 Years

In an effort to constantly provide our valued customers with the latest advancements in technology, Factor Electronics specifications are subject to change from time to time without notice.

Contact Information:

Factor Electronics
#108-19232 Enterprise Way
Surrey B.C. Canada V3S-6J9
PH: 778-574-3883
E-Mail: info@factorelectronics.com
Web: www.factorelectronics.com

Warranty

Factor Electronics amplifiers are warranted to be free from defects in workmanship and materials for a period of three (3) years from the date of purchase without charge for parts or labour. This warranty applies only to the original owner. The owners responsibilities are to provide proof of purchase from an authorized Factor Electronics dealer/distributor and transportation to the dealer/distributor the unit was purchased from or Factor Electronics. This warranty does not apply to units that have been subject to misuse, abuse, neglect or improper installation, and does not apply to repairs or alterations made by unauthorized personnel. This warranty specifically excludes responsibility for consequential damage. Retention of your original bill of sale is required to obtain service under the terms of this warranty.

©2012 Factor Electronics. All rights reserved.
All trademarks are the property of their respective owners. Specifications are subject to change without notice. Factor Electronics is not responsible for typographical errors or omissions.